

Contents

AR-723-U

1 Product



2 Terminal Cables



AR-721-K

1 Product



2 Terminal Cables

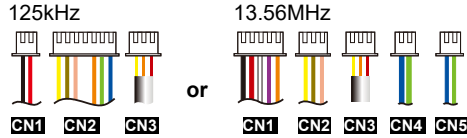

3 Tools



e x1

AR-725-U-M

1 Products



(725-UB-M)

(725-UD-M)

2 Terminal Cables

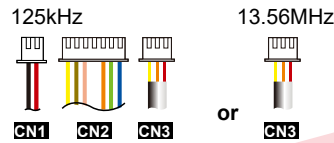

3 Tools

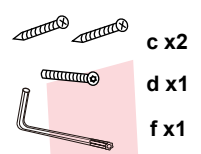

c x2

d x1

f x1

AR-725-U

1 Products



(725-UB)

(725-UD)

2 Terminal Cables

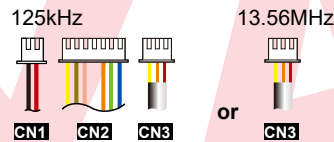

3 Tools



e x1

AR-725-K-M

1 Products

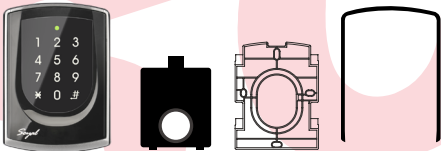

2 Terminal Cables

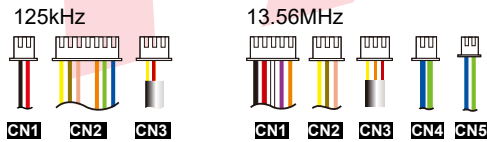

3 Tools

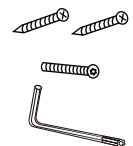

c x2

d x1

f x1

AR-725-K

1 Products

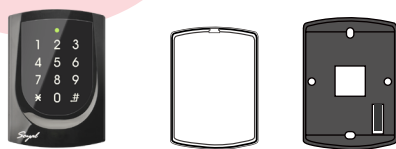

2 Terminal Cables

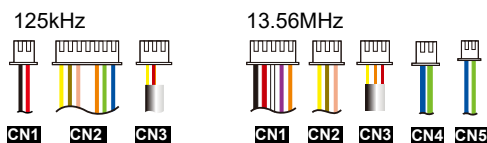

3 Tools

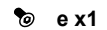

e x1

AR-725X

1 Products

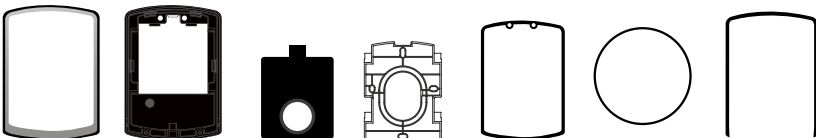

2 Tools

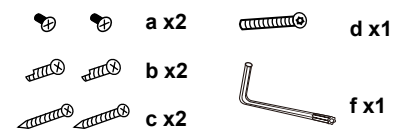

a x2

d x1

b x2

c x2

f x1

AR-661U [Long Range Proximity Reader]

1 Product



2 User Guide



x2

3 Standard Card

[Read Only and Thick]



x4

Parts Description

- a. Button Head Pozidriv Tapping Screw: M3x10
- b. Button Head Pozidriv Slotting Screw: 2.5x10
- c. Flat Head Cap Philips Tapping Screw: 4x19.1
- d. Security Torx Screw: M3.5x15
- e. Flat Head Hex Socket Screw: M3x8
- f. Hex Socket Screw

AR-723-U Terminal Cable (125kHz)

Wire Application	Wire	Color	Description
Power	1	Black	DC Power 0V (GND)
	2	Red	DC Power 12V
Beeper	3	Purple	Beeper Input (Low Sound)
LED	4	Brown	LED Green Input
LED	5	Yellow	LED Red Input
Card Present	6	White	Card Present
Wiegand	7	Green	Wiegand DAT:0 Output
	8	Blue	Wiegand DAT:1 Output
Beeper	9	Gray	Beeper Output
	10	Orange	--

Output Selection

Output	232 (TTL)/ABA (DIP_SW1)	26/34 (DIP_SW2)
WG26	OFF	OFF
WG34	OFF	ON
RS-232 (TTL:By order)	ON	OFF
ABA II	ON	ON

AR-723-U RS-232 TTL:By order) Format: 9600, N, 8, 1

DAT:0: TTL Inverted Serial Output.(Connect to PC COM port)

DAT:1: TTL Serial Output.

(Connect to PC COM port through RS-232 invert driver)

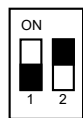

WG34
AR-723-U[125kHz]

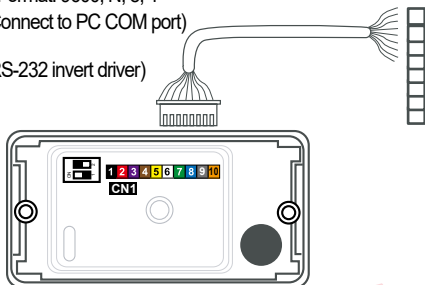

AR-723-U Terminal Cable (13.56MHz)

Wire Application	Wire	Color	Description
Power	1	Black	DC Power 0V (GND)
	2	Red	DC Power 12V
Beeper	3	Purple	Beeper Input (Low Sound)
LED	4	Brown	LED Green Input
LED	5	Yellow	LED Red Input
Card Present	6	White	Card Present
Wiegand	7	Green	Wiegand DAT:0 Output
	8	Blue	Wiegand DAT:1 Output
Networking	9	Gray	RS-485(A+)
	10	Orange	RS-485(B-)

Output Selection

Output	26/34(DIP_SW1)	232(TTL)/ABA(DIP_SW2)
WG26	ON	OFF
WG34	OFF	OFF
ABAI	OFF	ON
RS-232(TTL:By order)	ON	ON



WG34
AR-723-U[13.56MHz]

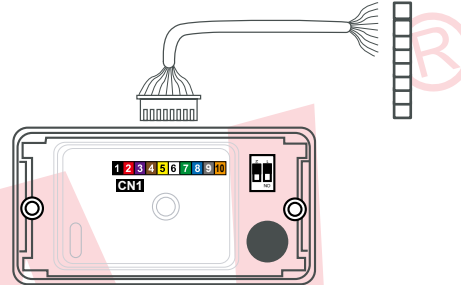

AR-723-U Protocol Description

[i.e.] Card Number = 01234:56789

Echo	Value	Description
Head	7E	Initial Value
Length	09	Compute the data length from Node to the end including XOR and SUM
Node	00	The value 00 is fixed, the message would be sent to PC from the device
Function	00	The value 00 is fixed, the message would be sent to PC from the device
Data Field	71	Data receiving from AR-723-U
	04	Site H Site Code – High Site Hi Site Lo = 0x4D2
	D2	Site L Site Code – Low Site Code: 01234
	DD	Card H Card Code – High Card Hi Card Lo = 0xDDD5
	D5	Card L Card Code – Low Card Code: 56789
XOR	01	CID ID Code [Bits(39~32)]
SUM	51	XOR=FF^00^71^04^D2^DD^D5^01 =51
	4B	SUM=(00+71+04+D2+DD+D5+01+51) · FF=4B(LSB)

AR-723-U/AR-725-U Networking Diagram

Mifare[13.56MHz]

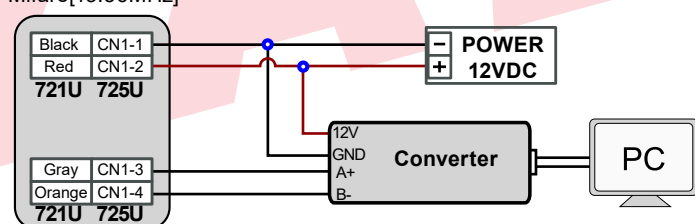

AR-723-U	AR-725-U	Function
Black	CN1-1	DC 0V
Red	CN1-2	DC 12V
Gray	CN1-3	RS-485(A+)
Orange	CN1-4	RS-485(B-)

AR-725-U Terminal Cable (125kHz, Before S/N: 1610)

AR-725-U [125kHz] Cable: **CN1**

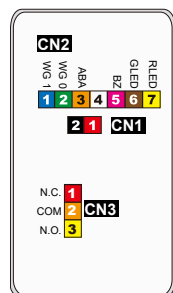

Wire Application	Wire	Name	Description
Power	1	GND	DC Power 0V
	2	12V	DC Power 12V

Cable: **CN2**

Wire Application	Wire	Name	Description
Wiegand	1	DAT: 1	Wiegand DAT: 1 Output
	2	DAT: 0	Wiegand DAT: 10 Output
---	3	---	---
Card Present	4	CP	Card Present
Beeper	5	BZ	Beeper Input(Low Sound)
LED	6	GLED	LED Green Input (Low Bright)
	7	RLED	LED Red Input (Low Bright)

Cable: **CN3**

Wire Application	Wire	Color	Description
Tamper Switch	1	Red	N.C.
	2	Orange	COM
	3	Yellow	N.O.

AR-725-U Terminal Cable (13.56MHz)

AR-725-U [13.56MHz] **CN1**

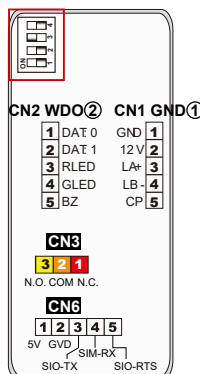

Wire Application	Wire	Name	Description
Power	1	GND	DC Power 0V
	2	12V	DC Power 12V
Networking	3	LA+	RS-485(A+)
	4	LB-	RS-485(B-)
---	5	CP	Card Present

CN2

Wire Application	Wire	Name	Description
Wiegand	1	DAT: 0	Wiegand DAT: 0 Output
	2	DAT: 1	Wiegand DAT: 1 Output
LED	3	RLED	LED Red Input (Low Bright)
	4	GLED	LED Green Input (Low Bright)
Beeper	5	BZ	Beeper Input (Low Sound)

Cable: **CN3**

Wire Application	Wire	Color	Description
Tamper Switch	1	Red	N.C.
	2	Orange	COM
	3	Yellow	N.O.

AR-725-U Terminal Cable (13.56MHz)

Dip-switch

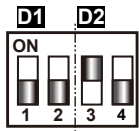

Output format	DIP_SW1	DIP_SW2
WG-26	ON	OFF
WG-34	OFF	OFF
ABA_II	OFF	ON
RS-232(TTL)	ON	ON

DIP_SW3	DIP_SW4
Open RS-485	ON
Open RFID_SIM	OFF

AR-661U Terminal Cable (125kHz only)

Installation Notice

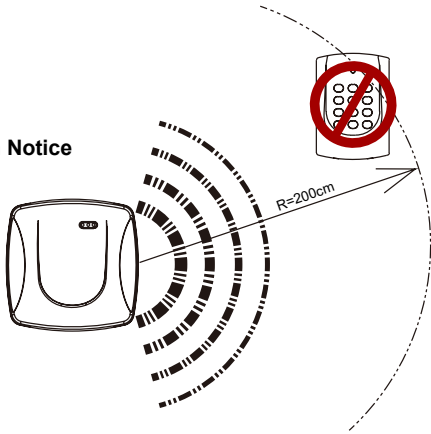

Wire Application	Wire	Color	Description	Remark
Power	1	Black	DC 0V (GND)	regulated
	2	Red	DC 12V~18V	
Beeper	3	Purple	Beeper Output	
Wiegand	4	Green	Wiegand DAT:0	Open collected
	5	White	Card Present	
Wiegand	6	Blue	Wiegand DAT:1	Open collected
Output Selection	7	Yellow	SET1	
	8	Brown	SET2	
	9	Gray	SET3	Reserve

Output Selection	WG26	WG34	RS-232 (TTL)	WG34 + 4
SET 1	Open	Short to GND	Open	Short to GND
SET 2	Open	Open	Short to GND	Short to GND

※ Note:

WG34+4: Follow 0101 after WG34 data stream for reader identification.

AR-661U Installation

721-H with 2 pcs of 661U for two-door anti-pass-back

※ Minimum distance between AR-661U & other proximity reader should be over 200cm; otherwise, both readers might interfere each other.

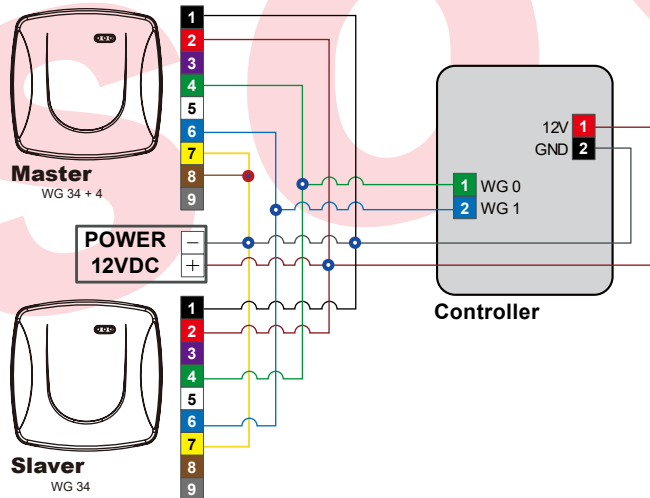

Improvement of RF interference for 2 pcs of 661U

Single Reader (RF always ON) (RF switching)

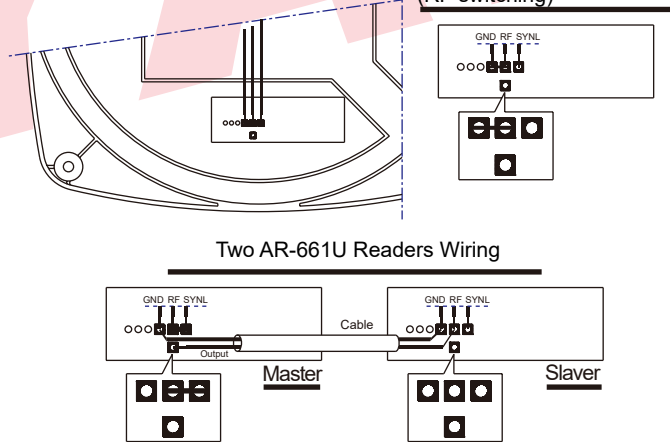

AR-723-U/AR-725-U/AR-661U Diagram

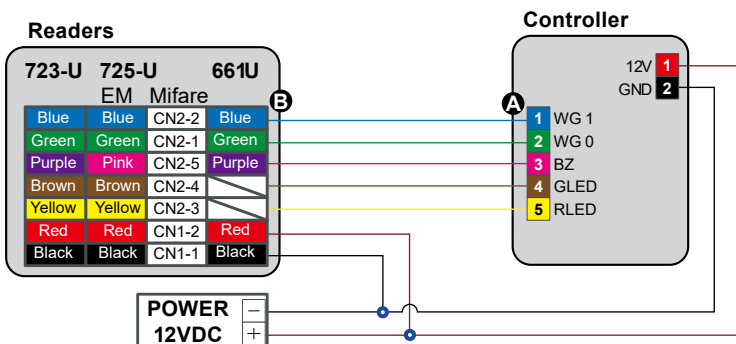

※ When the distance between two AR-661U readers is less than 6m (recommended value), the sensing distance will be shortened. However, you can use this method to avoid interference.

※ No 661U needs to connect to LED

AR-723-U	AR-725-U	AR-661U	PIN	Function
Blue	Blue	CN2-2	Blue	DAT: 1
Green	Green	CN2-1	Green	DAT: 0
Purple	Pink	CN2-5	Purple	BEEP
Brown	Brown	CN2-4	---	Brown
Yellow	Yellow	CN2-3	---	Yellow

AR-721-K/725-K Terminal Cable (125kHz) / AR-725-U Terminal Cable (125kHz,After S/N: 1611)

Cable: CN1

Wire Application	Wire	Color	Description
Power	1	Red	DC Power 12V
	2	Black	DC Power 0V

Cable: CN2

Wire Application	Wire	Color	Description
Wiegand	1	Thin Blue	Wiegand DAT: 1 Input ABA Format: Clock
	2	Thin Green	Wiegand DAT: 0 Input ABA Format: Data
ABA	3	Orange	ABA Format: Card Present
	4		No Connection
Beeper	5	Pink	Beeper Input (Low Sound)
LED	6	Brown	LED Green Input (Low Bright)
	7	Yellow	LED Red Input (Low Bright)

Cable: CN3

Wire Application	Wire	Color	Description
Tamper Switch	1	Red	N.C.
	2	Orange	COM
	3	Yellow	N.O.

Wiegand Output Format

Output Format	WG	J2	RST/Bits
Wiegand 26 Bit	Open	Open	Open
Wiegand 34 Bit	Open	Open	Short
RS-232	Short	Open	Open
Magnetic (ABA 8 Digital)	Short	Open	Short
Magnetic(ABA 10 Digital)	Short	Open	Open

EM(125kHz)

※ Cable position is showed in the Terminal Cable

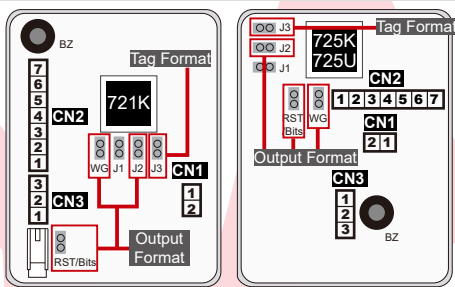
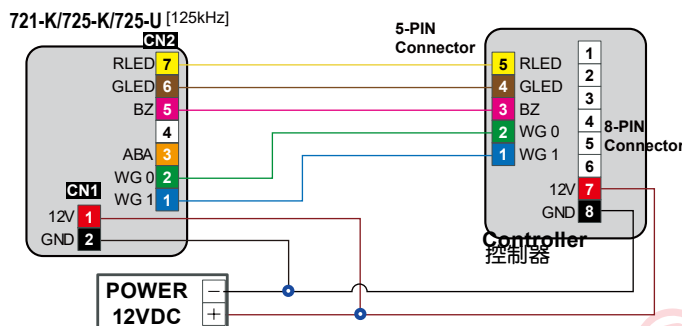

Tag Format	J3
SOYAL Format	Short
EM Format [Default]	Open

AR-721-K [125kHz]

AR-725-K/U [125kHz]

AR-721-K/725-K Terminal Cable (13.56MHz)

Cable: CN1

Wire Application	Wire	Color	Description
Output Format	1	Orange	SET2
	2	Purple	SET1
	3	White	ABA Format / Reading card
Power	4	Thick Red	DC 12V
	5	Thick Black	DC 0V (GND)

Cable: CN2

Wire Application	Wire	Color	Description
Beeper	1	Pink	Beeper Input (Input Low)
LED	2	Brown	LED Green Input (Input Low)
	3	Yellow	LED Red Input (Input Low)

Cable: CN3

Wire Application	Wire	Color	Description
Tamper Switch	1	Red	N.C.
	2	Orange	COM
	3	Yellow	N.O.

Cable: CN4

Wire Application	Wire	Color	Description
Networking Module	1	Thick Green	RS-485 (B-)
	2	Thick Blue	RS-485 (A+)

Cable: CN5

Wire Application	Wire	Color	Description
2-PIN Connector	1	Thin Green	WG DAT:0 Output ABA Format: Data
Wiegand	2	Thin Blue	WG DAT:1 Input ABA Format: Clock

Mifare(13.56MHz)

721-K/725-K [13.56MHz]

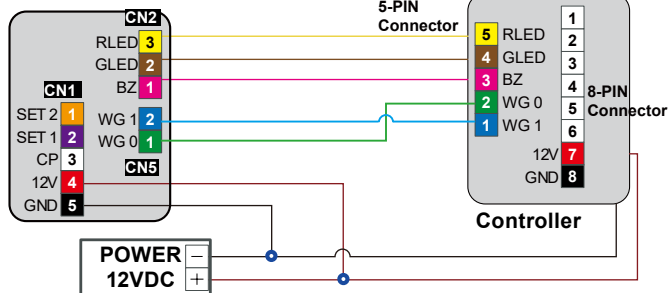

※ Cable position is showed in the Terminal Cable

Output Format

Output Format	SET 1	SET 2	Note
WG-26	Open	Open	Hex
WG-34	Open	Short to GND	Hex
ABA-10	Short to GND	Open	BCD 10
ABA-5-5	Short to GND	Short to GND	BCD 5:5

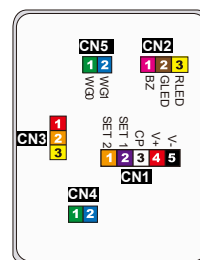
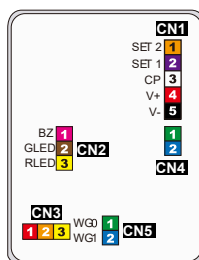

AR-721-K [13.56MHz]

AR-725-K [13.56MHz]